

SCS GO | SCS PRO

CENTRAL FILTER SYSTEM

The SCS is a floor-mounted filter system that provides filtration for use in multiple arm systems or general filtration systems. Extraction is done by single fans or a central fan. The SCS is available in eight different versions as far as the airflow direction is concerned.

The SCS is fitted with a *RoboCleanPlus* system for automatic section wise cleaning of the filter cartridges by compressed air. The dust and dirt particles fall into in the drum underneath.

Including intelligent control equipment ControlGo or ControlPro (refer to separate product data sheets) and filter cartridges type FCC-150.



APPLICATIONS

The SCS is intended to be used for the following applications:

- MIG-MAG/GMAW welding
- TIG welding
- FCAW welding
- stick/MMAW welding



SPECIFICATIONS

Physical dimensions and properties

Material:	
• filter housing	• steel
• base	• LMDPE (linear medium density polyethylene)
• frame	• steel
Colour:	
• filter housing	• grey RAL 7035
• base	• grey RAL 7024
• frame	• black RAL 9005
Weight (net)	260 kg (573 lbs)
Drum contents	100 litres (26 gallon)
Required floor space: SCS + PSC + SIF-1200 LI/RI	min. 325 x 137 cm (128 x 54 in.)

Filter cartridges

Type	FCC-150 (2-piece)
Filter surface area	2 x 75 m ² (2 x 807 ft ²)
Material	78% cellulose / 22% resin (phenol with flame retardant impregnation F1)
Treatment	SurfacePlus precoat
Dust class	M according to DIN EN 60335-2-69

RoboCleanPlus filter cleaning system

Required compressed air quality	dry and oil-free according to ISO 8573-3 class 6
Required pressure	6 bar (90 PSI)
Compressed air connection	quick connection coupling Ø 9 mm (CEJN 320)
Compressed air consumption	max. 150 nl/min. (5.3 ft ³ /min.) (depending on the degree of saturation of the filter)

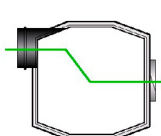
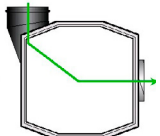
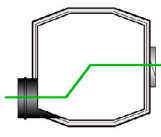
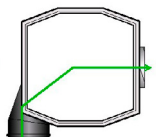
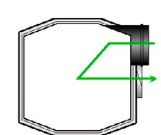
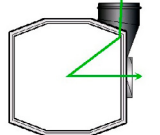
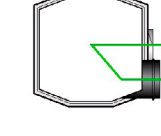
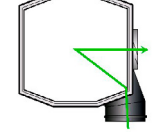

Duration off-line cleaning cycle	approx. 1 hour
Performance	
Capacity	max. 9000 m ³ /h (5300 CFM)
Ambient conditions	
Process temperature:	
• min.	• 5°C (41°F)
• nom.	• 20°C (68°F)
• max.	• 45°C (113°F)
Max. relative humidity	75%
Outdoor use allowed	no
Storage conditions	• 5-45°C (41-113°F) • relative humidity max. 75%
Options and accessories	
Spark arrester:	
• SparkShield-250/400/500	cyclonic spark arrester
• PSC	pre-separator
Filter cartridges:	
• FCC-150/HE	filter cartridge 2 x 75 m ² (cellulose and polyester fibres; filter class MERV 16 according to ASHRAE 52.2)
• FCP-110	filter cartridge 2 x 55 m ² (polyester fibres; SurfacePlus precoat; dust class M according to DIN EN 60335-2-69)
Scope of supply	
Assembled SCS filter unit (air inlet module and filter cartridges) - Frame - Dustbin - Dustbin trolley - Hardware - Control equipment	

■ Order information		
Filter systems	Air inlet module	
	0°	90°
Airflow: from <u>left rear</u> to right • SCS GO • SCS PRO	 0000113117 0000113125	 0000113118 0000113126
Airflow: from <u>left front</u> to right • SCS GO • SCS PRO	 0000113119 0000113127	 0000113120 0000113128
Airflow: from <u>right rear</u> to right • SCS GO • SCS PRO	 0000113115 0000113123	 0000113116 0000113124
Airflow: from <u>right front</u> to right • SCS GO • SCS PRO	 0000113121 0000113129	 0000113122 0000113130
Filter cartridges: • FCC-150 • FCC-150/HE • FCP-110	9850060080 (spare) 9850060260 (option) 9850060100 (option)	
■ Shipping data		
Gross weight		
Packing dimensions		
Harmonized Tariff Code	8537.1091.90	
Country of origin	Netherlands	

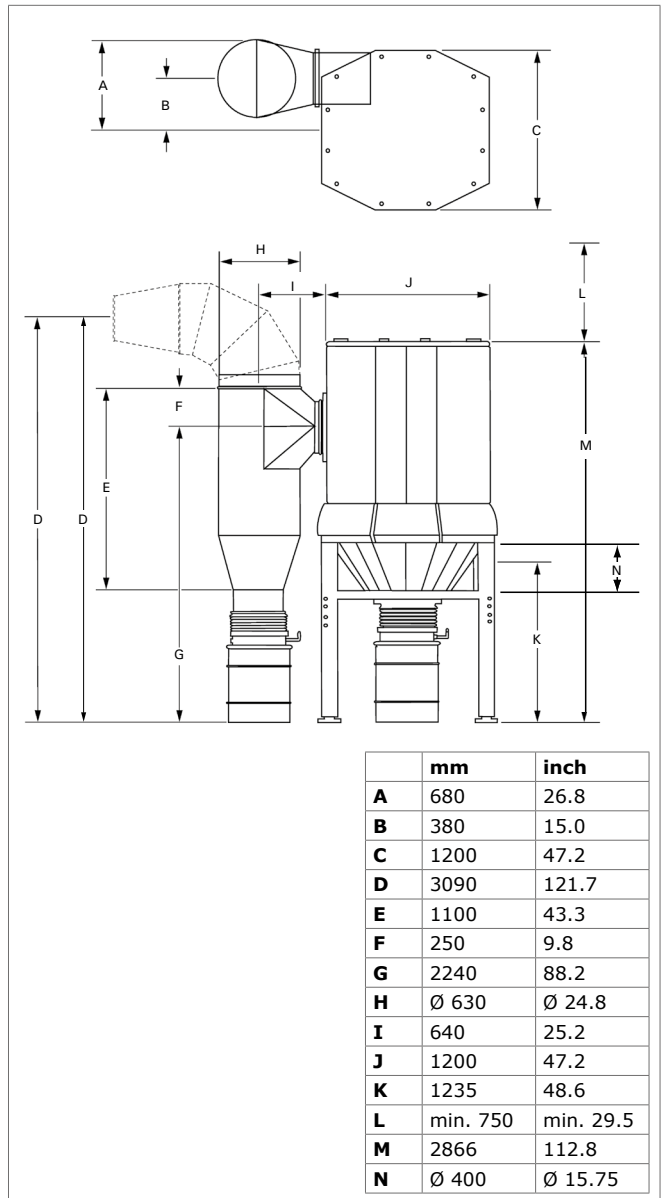
DIMENSIONS SCS + PSC



APPROVALS/CERTIFICATES

	
	Directive 2011/65/EC (RoHS) valid as of 8 June 2011

FEATURES & BENEFITS

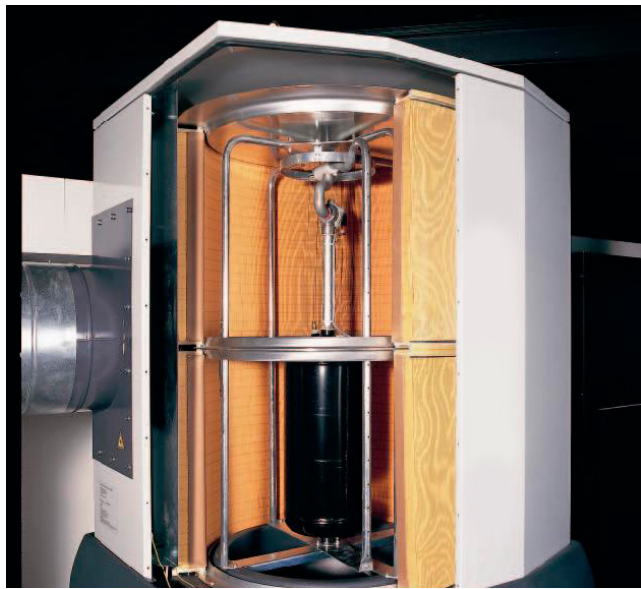

RoboCleanPlus automatic filter cleaning system

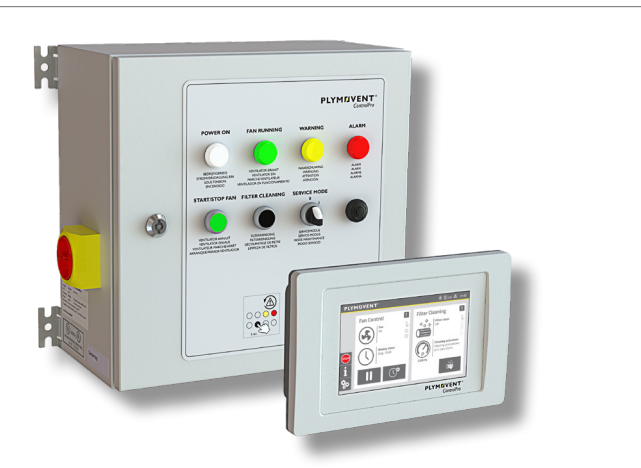

SCS GO: ControlGo

- control panel for basic fan/filter control

SCS PRO: ControlPro

- control panel with HMI with extensive feature package for fan/filter control; remote access via network

Intelligent control equipment

Application restrictions

Do **not** use the product for the following applications or in the following circumstances: polishing applications in combination with grinding, welding or any other application that generate sparks (fibres from polishing or abrasive flap disks are highly flammable and pose a high risk of filter fires when exposed to sparks) | aluminium laser cutting | oil mist | heavy oil mist in welding fume | arc-air gouging | extraction of aggressive fumes and gases (e.g. from acids, from alkaline, from soldering paste containing lithium) | extraction of hot gases (more than 70°C/158°F continuously) | grinding aluminum and magnesium | flame spraying | extraction of cement, saw dust, wood dust etc. | sucking cigarettes, cigars, oiled tissues and other burning particles, objects and acids | explosive environments or explosive substances/gases

Product type

SCS GO | SCS PRO

Article no.

refer to order information

Product category

central filter systems

Version

120221/H

Always check the latest version on www.plymovent.com